

Quick Installation Guide

300Mbps Wireless N USB ADSL2+ Modem Router

Please select your preferred setup wizard.

CD Setup Wizard
For Windows users only

Web-based Quick Setup Wizard
For Mac OS/Linux/Windows users who are unable to run the Resource CD

MODEL NO. TD-W8968

Package Contents

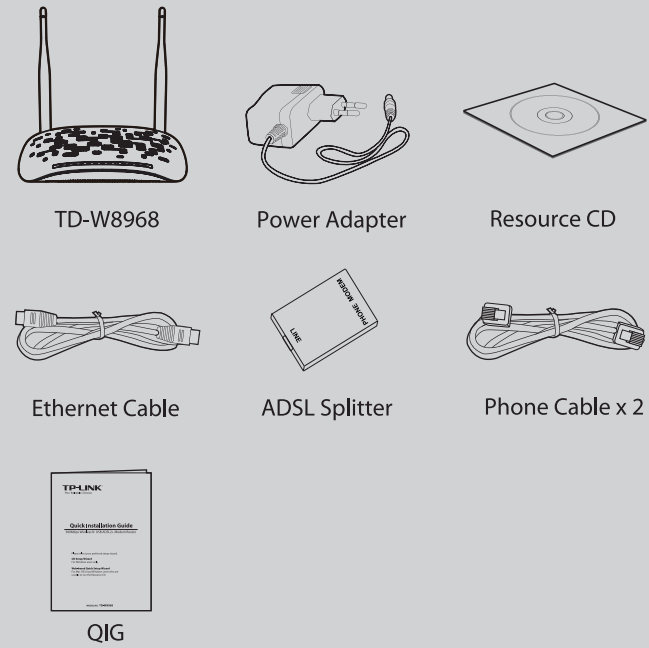

Necessary Information

For a smoother setup, we suggest that you consult your ISP first and ask for the following information. This information will be required during the configuration stage.

VPI/VCI: _____ Connection Type: _____
Encapsulation Type (Optional): _____

CD Setup Wizard (For Windows users only)

1 Insert the TP-LINK Resource CD into the CD-ROM drive.

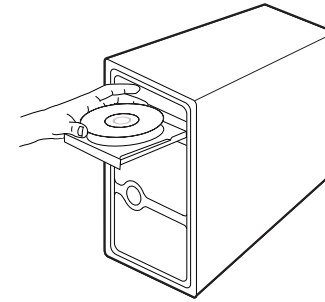

2 Select **TD-W8968** and click **Start Setup**.



3 Then a flash video will pop up and show you how to connect your devices. When you finish the hardware connection, click to continue.

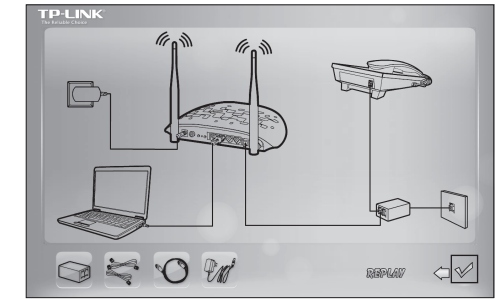

4 The Easy Setup Assistant will start. Please check to see if the LEDs (especially the ADSL LED) of your modem router display normally as the chart describes. Then click **NEXT**, and follow the step-by-step instruction until you complete the configuration.

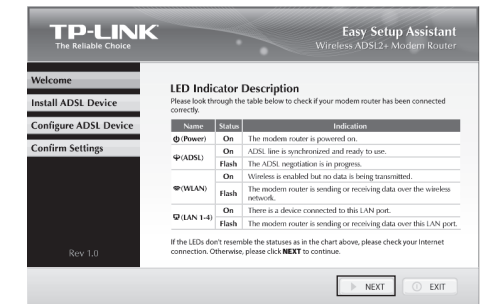

For the advanced configurations, please refer to the User Guide on the Resource CD provided. You can also log on to www.tp-link.com -> select your region -> search for the product -> User Guide can be found under the "Download" tab on the product page.

Web-based Quick Setup Wizard (For Mac OS/Linux/Windows users who are unable to run the Resource CD)

1 Hardware connection.

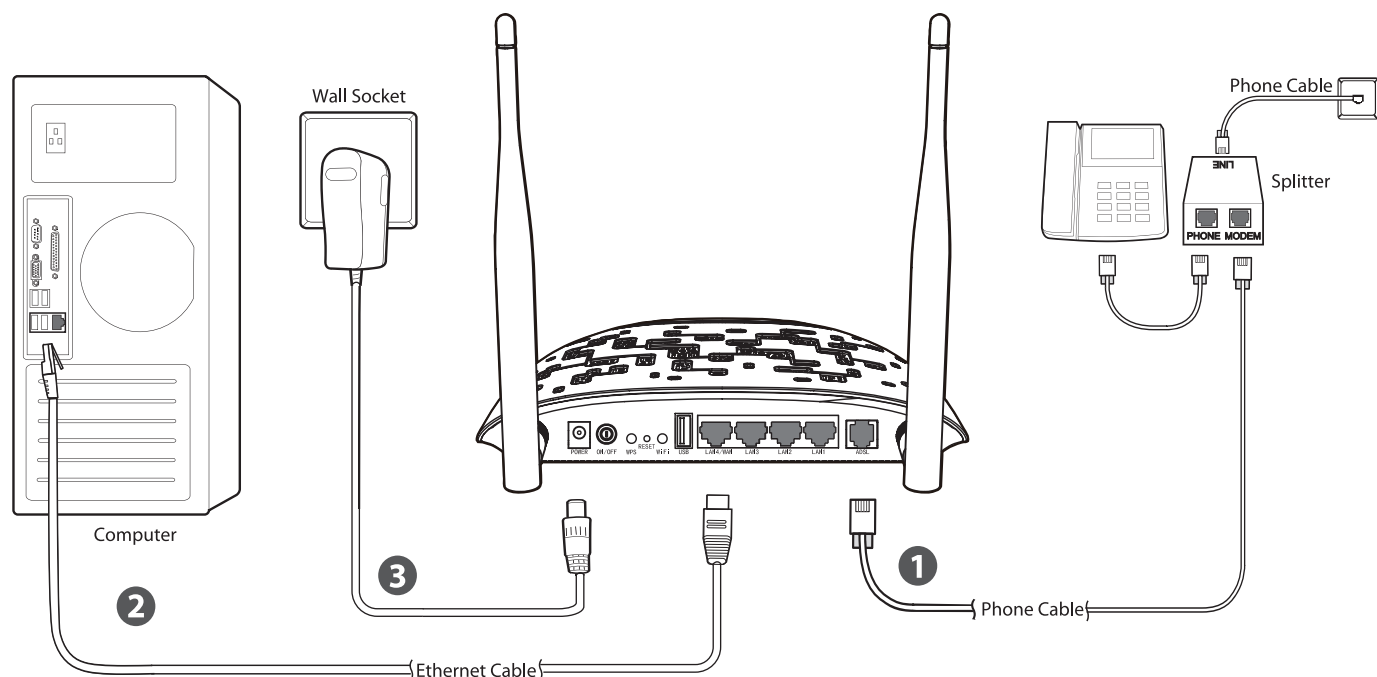

Step 1: Connect your devices step by step following the figure.

Step 2: Power on all your devices and then check the LEDs (especially the ADSL LED).

Name	Status	Indication
(Power)	On	The modem router is powered on.
(ADSL)	On	ADSL line is synchronized and ready to use.
(ADSL)	Flashing	ADSL negotiation is in progress.
(WLAN)	On	Wireless is enabled but no data is being transmitted.
(WLAN)	Flashing	The modem router is sending or receiving data over the wireless network.
(LAN 1-4)	On	There is a device connected to this LAN port.
(LAN 1-4)	Flashing	The modem router is sending or receiving data over this LAN port.

2 Open your browser and type <http://tplinkmodem.net> in the address field. Then use the default user name **admin** and password **admin** to log in.

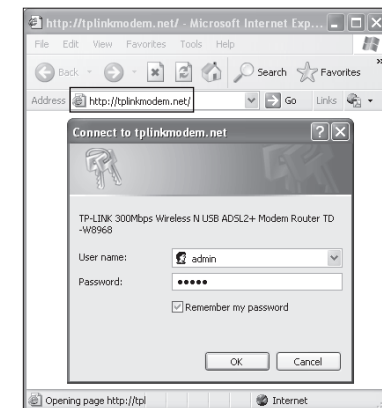

If you are unable to access tplinkmodem.net, please refer to **T3** in **Troubleshooting**.

3 Click **Quick Setup** in the left menu, the next screen will appear, and then click **Next**.

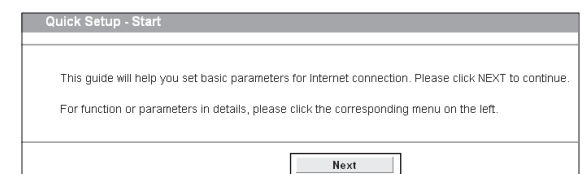

Web-based Quick Setup Wizard (For Mac OS/Linux/Windows users who are unable to run the Resource CD)

- 4** Select **Operation Mode** and then click **Next** to continue. Here we use **ADSL Modem Router Mode** as an example.

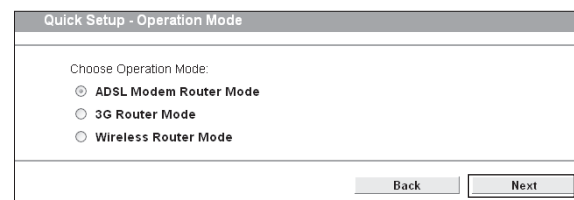

Note For **3G Router Mode** or **Wireless Router Mode** configuration, please refer to 3.2 Quick Installation Guide on User Guide. You can get the User Guide on Resource CD or download from our website www.tp-link.com

- 5** Select your **Country** and **ISP** from the drop-down list, then click **Next**. (If your country or ISP is not listed, please select **Other**. Enter **VPI/VCI** values and select **Connection type** provided by your ISP, then click **Next**.)

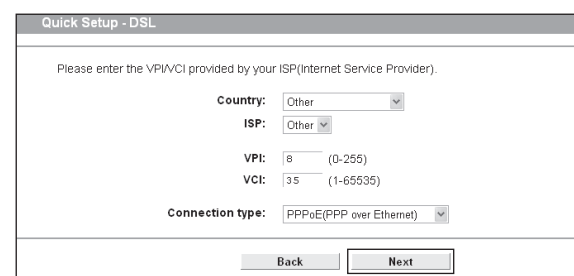

Note Select **Other** for your country or ISP, you can manually enter the **VPI/VCI** values and select **Connection type**.

- 6** Enter the PPPoE Username and Password provided by your ISP. After confirming the password, click **Next** to continue.

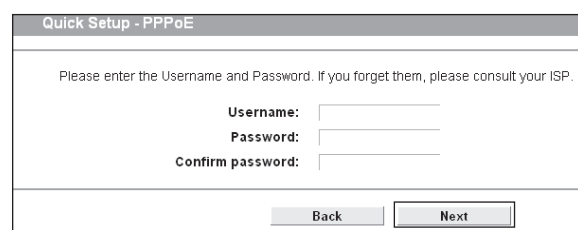

Record your PPPoE information here:

Username: _____
Password: _____

- 7** 3G backup function is disabled by default. Click **Next** to skip to the next step.

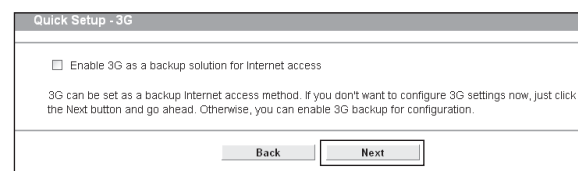

Note 3G can be set as a backup connection method if your current connection is unavailable. You can enable 3G backup function if needed and plug the 3G modem into the USB port of your modem router.

- 8** The WLAN function is enabled by default. Create an easy-to-remember Wireless Network Name (SSID). It is also strongly recommended to set a password for the wireless network to prevent outside intrusion. Click **Next** to continue.

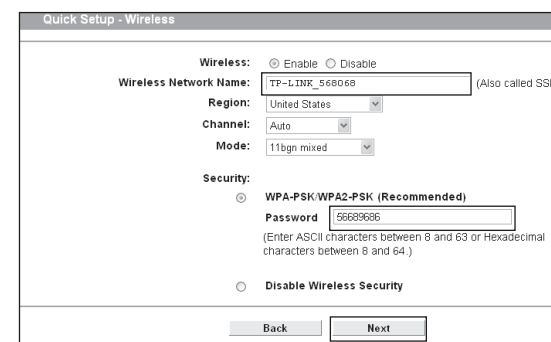

Note Disable Wireless Security is not recommended.

Record your wireless information here:

Wireless Network Name (SSID): _____
Password: _____

Note For the advanced configurations, please log on to www.tp-link.com -> select your region -> search for the product -> User Guide can be found under the "Download" tab on the product page.

- 9** Please confirm all parameters. Click **Back** to modify them or click **Save** to save your settings. Then the following page will display, click **Finish** to make your settings take effect.

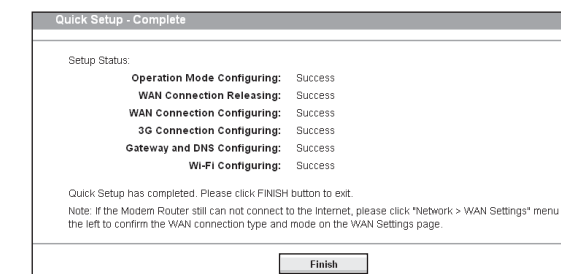

Troubleshooting

T1. How can I restore my modem router's configuration to its factory default settings?

Once the modem router is reset, the current settings will be lost and you will need to reconfigure the modem router. We strongly suggest you back up the current settings before resetting the modem router.

With the modem router powered on, use a pin to press and hold the RESET button on the rear panel for 8 to 10 seconds before releasing it.

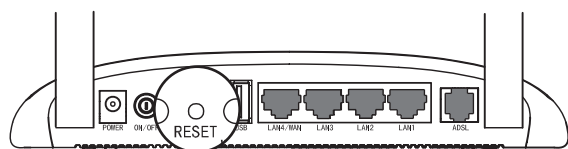

T2. What can I do if I forget my password?

- For default wireless password: Please refer to the "Wireless Password/PIN" labeled on the bottom of the modem router.
- For the web management page password: Reset the modem router first and then use the default user name and password: **admin/admin**.

T3. What can I do if I cannot access tplinkmodem.net?

For Mac OS X

- Click the **Apple** icon on the upper left corner of the screen.
- Go to "**System Preferences -> Network**".
- Select **Airport** on the left menu bar, and then click **Advanced** for wireless configuration; or select **Ethernet** for wired configuration.

- In the **Configure IPv4** box under **TCP/IP**, select **Using DHCP**.
- Click **Apply** to save the settings.

For Windows 7

- Click "**Start -> Control Panel -> Network and Internet -> View network status -> Change adapter settings**".
- Right-click **Wireless Network Connection** (or Local Area Connection), and then click **Properties**.
- Select **Internet Protocol Version 4 (TCP/IPv4)**, and then click **Properties**.
- Select **Obtain an IP address automatically** and **Obtain DNS server address automatically**. Then click **OK**.

For Windows XP

- Click "**Start -> Control Panel -> Network and Internet Connections -> Network Connections**".
- Right-click **Wireless Network Connection** (or Local Area Connection), and then click **Properties**.
- Select **Internet Protocol (TCP/IP)**, and then click **Properties**.
- Select **Obtain an IP address automatically** and **Obtain DNS server address automatically**. Then click **OK**.

For Windows 8

- Move your mouse to the lower right corner and click the **Search** icon in the Popups.
- Go to **Apps**, type **Control Panel** in the search box and press **Enter**.
- Go to "**Control Panel -> View network status and tasks > Change adapter settings**".
- Right-click **Ethernet**, select **Properties**. Then double-click **Internet Protocol Version 4 (TCP/IPv4)**.
- Select **Obtain an IP address automatically** and **Obtain DNS server address automatically**. Then click **OK**.

T4. What can I do if I cannot access the Internet?

- Check your cables and make sure they are all plugged in securely, including the telephone line, Ethernet cables and power adapter.
- Check to see if you can log on to the web management page of the modem router. The default address of the web management page is **tplinkmodem.net**. If you can, try the following steps. (If you are unable to access the web management page, please refer to **T3** and then try to access the Internet again after following those steps.)
- Consult your ISP and make sure all the VPI/VCI, Connection Type, account username and password are correct. If they are not, please replace them with the correct settings and try again.
- If you still cannot access the Internet, please restore your modem router to its factory default settings and reconfigure your modem router following the instructions in this QIG.
- Please feel free to contact our Technical Support if the problem still exists.

T5. How can I configure the USB features?

Please refer to our Application Guides. They can be found on the resource CD, or on the web.

- CD Access: Open Resource CD and find the folder named "Application Guide". The guides can be found inside this folder.
- Web Access: <http://www.tp-link.com/app/usb>

Note For more details about Troubleshooting and Technical Support contact information, please log on to our Technical Support website: <http://www.tp-link.com/en/support>



Technical Support

- For more troubleshooting help, go to <http://www.tp-link.com/en/support/faq>
- To download the latest Firmware, Driver, Utility and User Guide, go to <http://www.tp-link.com/en/support/download>
- For all other technical support, please contact us by using the following details:

Global Tel: +86 755 2650 4400 Fee: Depending on rate of different carriers, IDD. E-mail: support.us@tp-link.com Service time: 24hrs, 7 days a week	Australia / New Zealand Tel: NZ 0800 87 5465 (Toll Free) AU 1300 87 5465 (Depending on 1300 policy.) E-mail: support.au@tp-link.com (Australia) support.nz@tp-link.com (New Zealand) Service time: 24hrs, 7 days a week
USA / Canada Toll Free: +1 866 225 8139 E-mail: support.usa@tp-link.com Service time: 24hrs, 7days a week	Singapore Tel: +65 6284 0493 Fee: Depending on rate of different carriers. E-mail: support.sg@tp-link.com Service time: 24hrs, 7 days a week
UK Tel: +44 (0) 845 147 0017 Fee: Landline: 1p-10.5p/min, depending on the time of day. Mobile: 15p-40p/min, depending on your mobile network. E-mail: support.uk@tp-link.com Service time: 24hrs, 7days a week	Ukraine Tel: 0800 505 508 Fee: Free for Landline; Mobile: Depending on rate of different carriers E-mail: support.ua@tp-link.com Service time: Monday to Friday, 10:00 to 22:00
Turkey Tel: 0850 7244 488 (Turkish Service) Fee: Depending on rate of different carriers. E-mail: support.tr@tp-link.com Service time: 09:00 to 21:00, 7days a week	Malaysia Toll Free: 1300 88 875 465 E-mail: support.my@tp-link.com Service time: 24hrs, 7days a week
Brazil Toll Free: 0800 608 9799 (Portuguese Service) E-mail: suporte.br@tp-link.com Service time: Monday to Friday, 09:00 to 20:00; Saturday, 09:00 to 15:00	Poland Tel: +48 (0) 801 080 618 +48 223 606 363 (if calls from mobile phone) Fee: Free for Landline; Mobile: Depending on rate of different carriers. E-mail: support.pl@tp-link.com Service time: Monday to Friday, 09:00 to 17:00. GMT+1 or GMT+2 (DST)
Italy Tel: +39 023 051 9020 Fee: Depending on rate of different carriers. E-mail: support.it@tp-link.com Service time: Monday to Friday, 09:00 to 13:00; 14:00 to 18:00	Switzerland Tel: +41 (0)848 800 998 (German Service) Fee: 4-8 Rp/min, depending on rate of different time
Indonesia Tel: (+62) 021 6386 1936 Fee: Depending on rate of different carriers. E-mail: support.id@tp-link.com Service time: Monday to Friday, 09:00 to 18:00 *Except public holidays	E-mail: support.ch@tp-link.com Service time: Monday to Friday, 09:00 to 12:30 and 13:30 to 17:30. GMT+ 1 or GMT+ 2 (DST)
Germany / Austria Tel: +49 1805 875 465 (German Service) +49 1805 TPLINK +43 820 820 360 Fee: Landline from Germany: 0.14EUR/min. Landline from Austria: 0.20EUR/min. E-mail: support.de@tp-link.com Service Time: Monday to Friday, 09:00 to 12:30 and 13:30 to 17:30. GMT+1 or GMT+2 (DST in Germany) * Except bank holidays in Hesse	France Tel: 0820 800 860 (French service) Fee: 0.118 EUR/min from France E-mail: support.fr@tp-link.com Service time: Monday to Friday, 09:00 to 18:00 *Except French Bank holidays
Russian Federation Tel: 8 (499) 754 5560 (Moscow NO.) 8 (800) 250 5560 (Toll-free within RF) E-mail: support.ru@tp-link.com Service time: From 10:00 to 18:00 (Moscow time) *Except weekends and holidays in RF	